

Stravifloor Jackup-R Datasheet

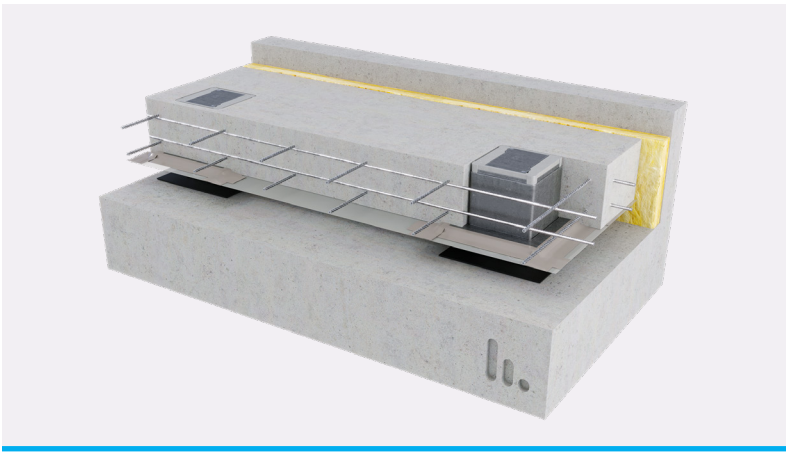

Stravifloor Jackup-R is an isolated floating floor system using reinforced steel boxes cast into concrete and jacked up after the concrete has cured, to provide the required void depth.

Once the concrete has cured, the isolated slab is raised off the structure to the required void depth. Stravifloor Jackup-R boxes allow for easy adjustment of the final floor height as well as replacement or inspection of isolators, should the use of the room or load conditions change in the future.

Stravifloor Jackup-R boxes have an extremely high load capacity and, therefore, allow for larger spans and fewer support points than traditional jack-up systems, to provide a cost-effective solution. Stravifloor Jackup-R reduces the risk of acoustic bridging between the floating floor slab and the subfloor.



CHARACTERISTICS

- Can be provided with elastomer bearings giving a natural frequency as low as 6Hz, or spring mounts giving a natural frequency 4.5Hz or 3Hz*
- Standard box heights are 4" (100 mm), 6" (150 mm) and 8" (200 mm) (any height from 4" (100 mm) upwards can be manufactured to special order or project requirement)
- Stravifloor Jackup-R boxes have an extremely high load capacity, allowing for larger spans
- Steel components are centrifugal hot-dip galvanized
- Spring or elastomeric isolators are accessible and replaceable even after installation and concrete pour
- Jack-up systems provide the lowest risk of acoustical bridges through poured concrete
- Stravifloor Jackup-R systems can have a shallow or adjustable air gap
- Can take high loads before the slab is raised (e.g. used as a storage area during construction)
- Eliminates the cost and need for formwork

* Standard springs are epoxy coated, suitable for C2 environments. Springs with special coating or special spring materials are available upon request for installation in outside conditions or other special environments.



SYSTEM COMPONENTS

Stravifloor Jackup-R box (elastomers)

Weight: 30 lbs (excl. elastomers)

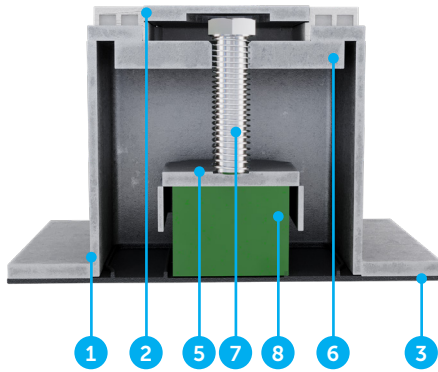

- 1. Reinforced steel box
- 2. Box lid
- 3. Bottom plate
- 4. Spring plate
- 5. Bearing cap
- 6. Adjustment plate

Stravifloor Jackup-R box (springs)

Weight: 30 lbs (excl. springs)

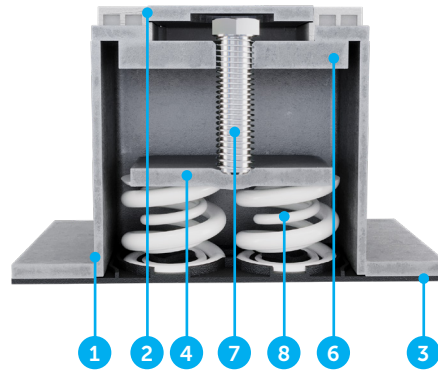

- 7. Bolt
- 8. Isolator (elastomer or spring)



Test Report AC-20-067-06 & AC-20-067-17 by Belgium Building Research Institute⁽¹⁾ - Test Setup

- 1. 6" (150 mm) [4" (100 mm) + 2" (50 mm)] reinforced concrete floating floor
- 2. Reinforced steel box with PAD-X50
- 3. PE-foil
- 4. 2" (50 mm) air void
- 5. 5.5" (140 mm) reinforced concrete slab

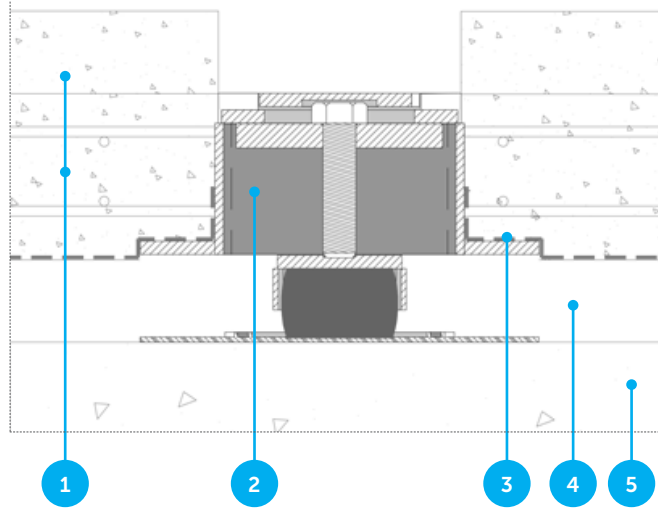

Acoustical Isolation

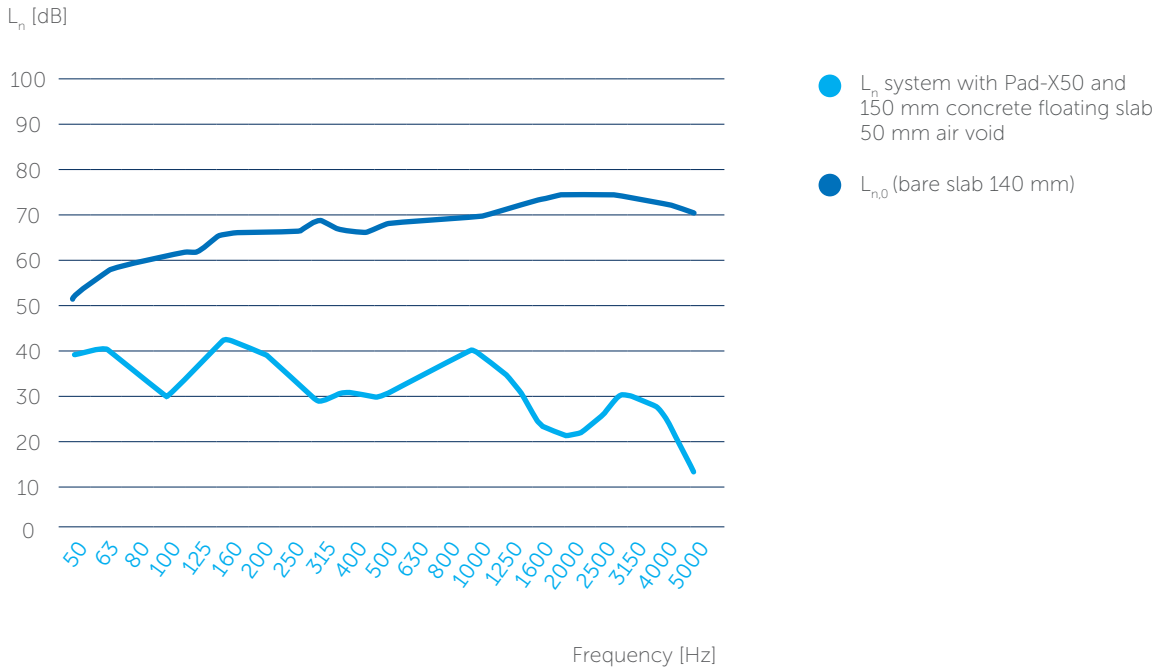

*Test report available upon request

Acoustical Isolation

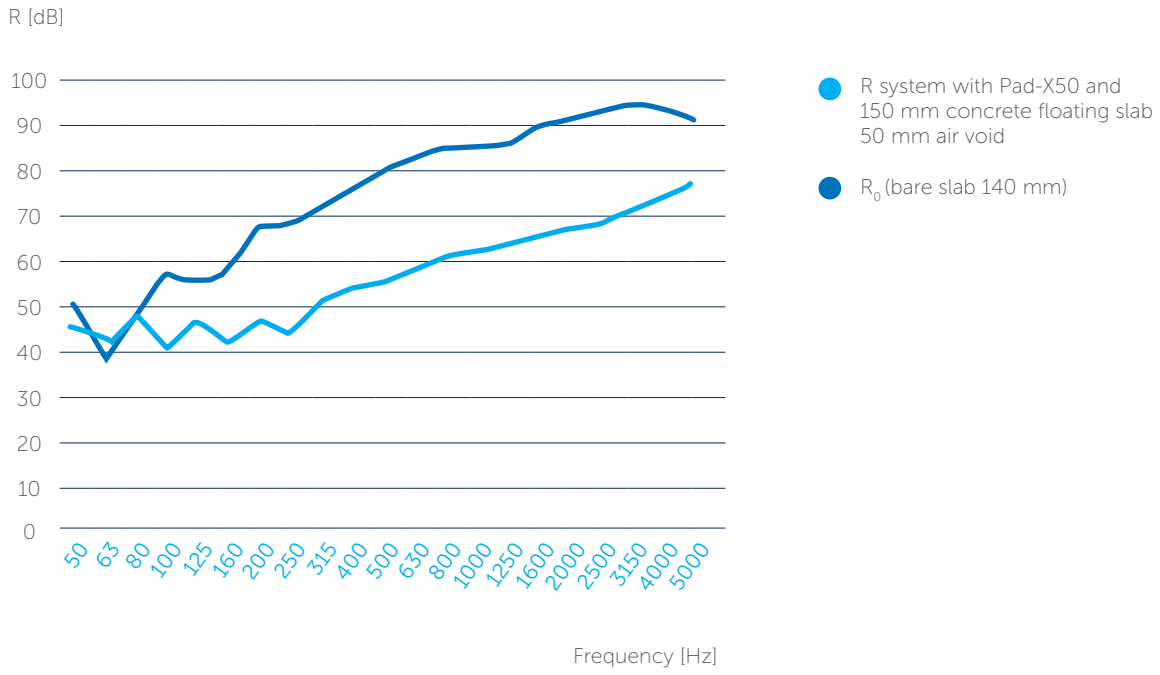

Setup	IIC	STC
System	78	78
Bare Slab	25	58



Test Report AC-20-067-07 & AC-20-067-18 by Belgium Building Research Institute⁽¹⁾ - Test Setup

- 1. 6" (150 mm) [4" (100 mm) + 2" (50 mm)] reinforced concrete floating floor
- 2. Reinforced steel box with 4.5Hz springs
- 3. PE-foil
- 4. 2" (50 mm) air void
- 5. 5.5" (140 mm) reinforced concrete slab

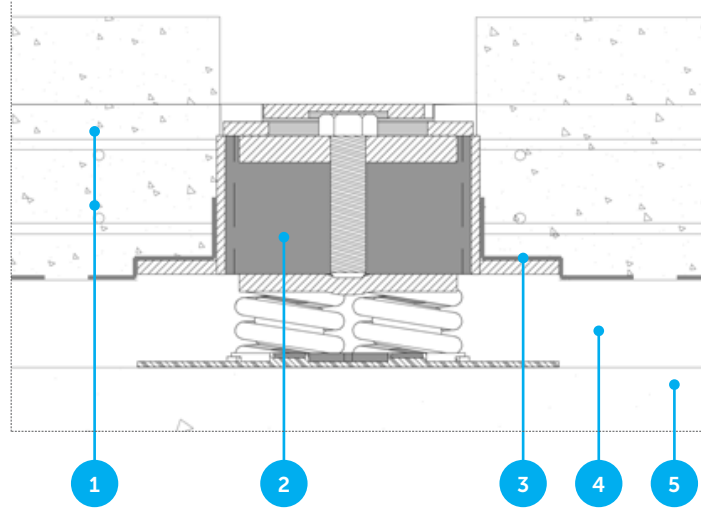

Acoustical Isolation

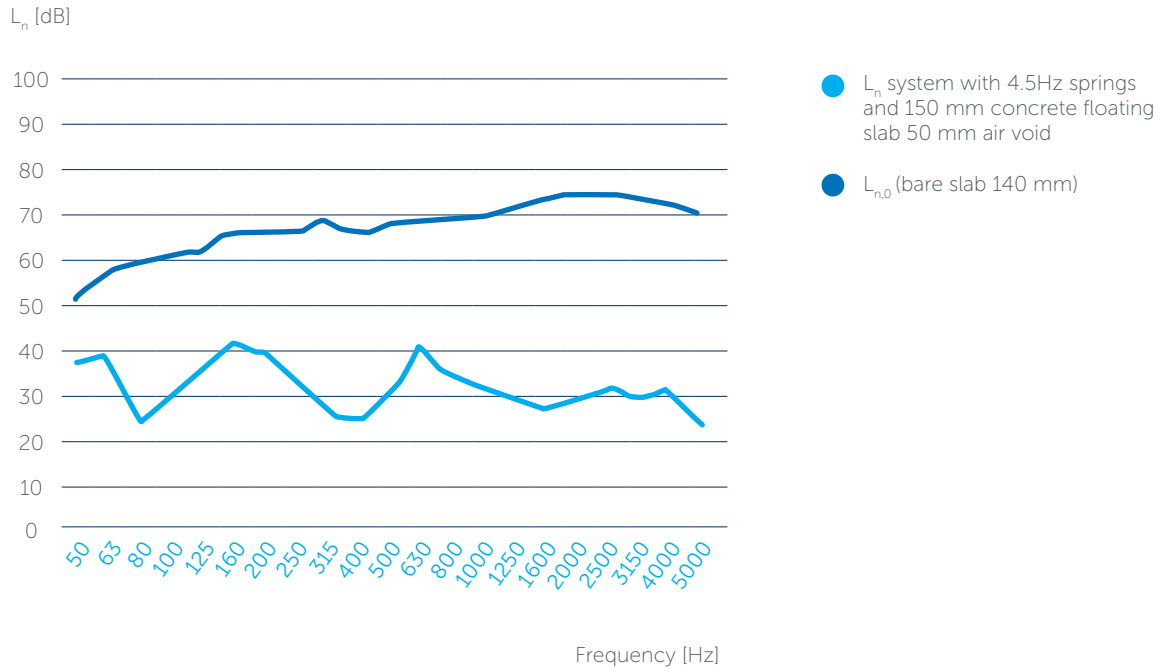

*Test report available upon request

Acoustical Isolation

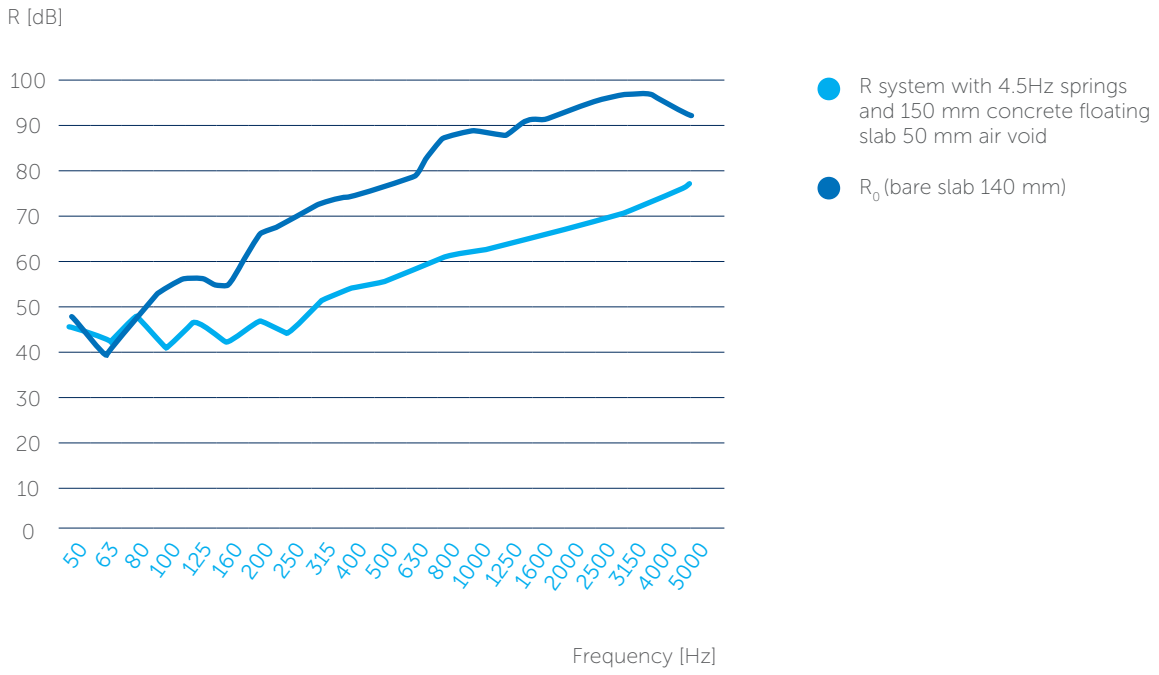

Setup	IIC	STC
System	71	75
Bare Slab	25	58



Stravifloor Jackup-R with springs

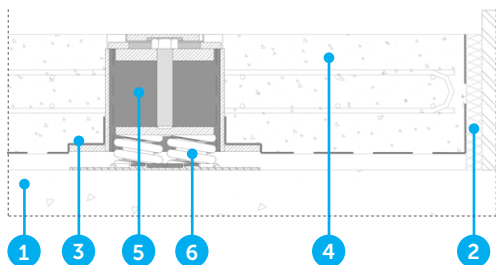

1. Reinforced concrete slab
2. Perimeter isolation
3. Protection foil (PE layer)
4. Reinforced concrete floating floor
5. Reinforced steel box
6. CDM Stravitec springs

Stravifloor Jackup-R with elastomeric pads

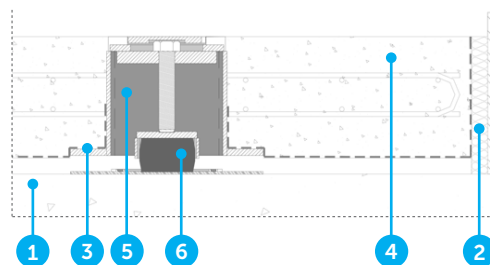

1. Reinforced concrete slab
2. Perimeter isolation
3. Protection foil (PE layer)
4. Reinforced concrete floating floor
5. Reinforced steel box
6. CDM Stravitec elastomeric pad

Note: an installation manual is available upon request.



Other Stravifloor Jackup-R assemblies available on our test data platform Stravi-dB.



SCAN ME

DISCLAIMER

This information is accurate to the best of our knowledge at the time of issue. Information, data and recommendations provided are based on industry accepted testing and prior product usage. It is intended as descriptive of the general capabilities and performance of our products and does not endorse applicability for any particular project. We reserve the right to change products, performance, and data without notice. This document replaces all information supplied prior to the publication hereof.