

cdm 
stravitec

Making your world a quieter place



BUILDING SERVICES & MECHANICAL EQUIPMENT
SOLUTIONS FOR NOISE & VIBRATION ISOLATION



Why CDM Stravitec?

For over 70 years, CDM Stravitec, a multi-generational family-owned company specializing in building acoustics and structural isolation, has been at the forefront of engineering, supplying, and installing innovative isolation solutions for buildings. These solutions are designed to effectively reduce noise and vibration transmission, enhancing the overall comfort, functionality, and safety of structures.

Mechanical services within a building constitute the cornerstone of these improvements, encompassing essential systems such as heating, ventilation, air conditioning (HVAC), plumbing, electrical infrastructure, and elevators.

Our expertise extends to designing isolation systems tailored to specific needs, whether addressing the source of vibration, the transmission path (including associated services or structural connections), or even the point where noise disturbances are received. We carefully assess cost and feasibility to provide optimal solutions. However, it's worth noting that, in many cases, elastically mounting building services and mechanical equipment proves to be the more cost-effective and efficient long-term approach. Therefore, it is advisable to consider elastic mounting solutions during the initial planning stages.

CDM Stravitec, a [Structural Acoustics](#) & [Vibration Isolation Technology](#) company.



INTERRUTTORE
GENERALE
ATTENZIONE
GENERAL SWITCH
ATTENTION







EXPERIENCE

Established in 1951, CDM Stravitec's reputation is built on a passion for solving noise and vibration problems, a professional approach, technical excellence, customer service, and, most of all, our people. Our clients rely on decades of experience and trust us to recommend the right solution to every project we undertake.



WORLDWIDE PRESENCE

With locations in North America, Europe, and Asia, CDM Stravitec is well-positioned to handle projects globally. No matter where you are, CDM Stravitec provides great customer service, engineered solutions, and on-site performance. The diversity of our multilingual staff provides an ideal creative source for understanding technical, practical, local, and cultural considerations. Hundreds of completed projects in more than 50 countries are testimony of our customer satisfaction.



ENGINEERING & CUSTOMIZATION CAPABILITIES

Our highly qualified team of engineers has a thorough understanding of the properties of sound generation, propagation and their effects using sophisticated calculation software to predict system performance and provide detailed drawings and installation plans for each project. As result our clients, direct or OEM, welcome and promote a collaborative working approach between their project teams and CDM Stravitec's design team.

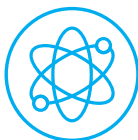

RESEARCH AND DEVELOPMENT

CDM Stravitec's ongoing R&D program continuously expands our understanding of raw materials, which enables us to always select the best solution independently of the type of elastomer used. Continuous investment into acoustical and mechanical property testing (in-house testing) allows us to provide material science and test reports for many applications. Collaboration with leading international universities and testing institutes enables us to develop high-performing acoustical solutions for tomorrow.



INSTALLATION ASSISTANCE

How well an acoustic solution performs largely depends on the quality of the installation and the care taken to eliminate possible mechanical bridging and noise flanking. By supervising installation and addressing any issues that may occur, we can provide the necessary warranties, giving you complete peace of mind.

Acoustically Isolating Building Services

Why & How

Modern buildings cannot function effectively without essential building services equipment - all of which produce noise and vibrations and, in many instances, are in close proximity to noise sensitive spaces.

The high isolation standards for building components means the existing background noise level inside apartments is becoming lower and consequently even the smallest building service equipment can generate annoyance.

Noise isolation measurements are generally required by local codes and implemented for the health and wellbeing of the building's occupants. Vibration isolation can also be relevant for protection of sensitive equipment.

The mechanical equipment will inevitably generate noise and vibration and, as they are usually mechanically secured to the supporting structure, high levels of structure-borne noise and vibration are likely. In order to mitigate this potential noise nuisance these machines, and their associated connections, must be decoupled from the supporting structure.

Examples of building services and mechanical equipment that may require noise and vibration control are: electrical transformers, generators, heating, ventilating and air conditioning systems (HVACs), control rooms, air handling units (AHUs), pump sets, extract fans, pipework, ducting and peripheral devices, lift systems (rails, motor, and electrical closet), heat pumps, chillers and cooling towers, compressors, and cogeneration plants (CHP).



ADVANTAGES

- Reduction of reradiated airborne noise
- Enhanced acoustic comfort
- Protection of sensitive building spaces from structural noise & vibration
- Protection of precision & quality of other sensitive equipment
- Prolonged machinery lifespan
- Lower maintenance needs



SOLUTIONS

- Isolated inertia bases (incl. floating floors)
- Anti-vibration mounts
- Isolated fixation/anchoring systems
- Isolated suspension systems



Continue reading for more information.

Selecting The Right Isolator

Overview

The management of undesirable vibrations or noise originating from machinery or equipment (the source) in relation to the support structure is known as “active isolation.” Conversely, the suppression of noise or vibration from the support structure to the equipment (the recipient) is referred to as “passive isolation.”

An isolator serves as a resilient support system designed to isolate an object from steady-state or externally induced vibrations, thereby diminishing the transmission of vibrations. Commonly utilized isolators include air mounts, steel helical springs, and elastomeric pads.

Two fundamental properties, the natural frequency (f_n) and damping (ζ), play a pivotal role in defining the transmissibility (T) of a system engineered for vibration isolation. Moreover, when selecting an isolator, various other critical factors come into play, including the source and nature of the dynamic disturbance, the isolator’s dynamic response to the disturbance, and the dynamic characteristics of the supporting structure.

The graph in Figure 1 illustrates how the ratio between the natural frequency of the isolator and the vibration source (β) influences the level of isolation (I).

For simplified system without damping, Transmissibility (T) can be calculated using the following formula: $T = \frac{1}{\beta^2 - 1}$

The isolation efficiency can be calculated as follows: $I (\%) = 100 \times (1 - T)$ and $I (dBV) = -20 \log(T)$

The grey line in the graph below does not consider isolator damping, the characteristics of the supporting structure, system stability, or scenarios involving multiple vibration sources, all of which can have a substantial impact on the outcome.

When incorporating damping into the equation, the transmissibility equation becomes: $T = \sqrt{\frac{1 + (2\zeta\beta)^2}{(1 - \beta^2)^2 + (2\zeta\beta)^2}}$

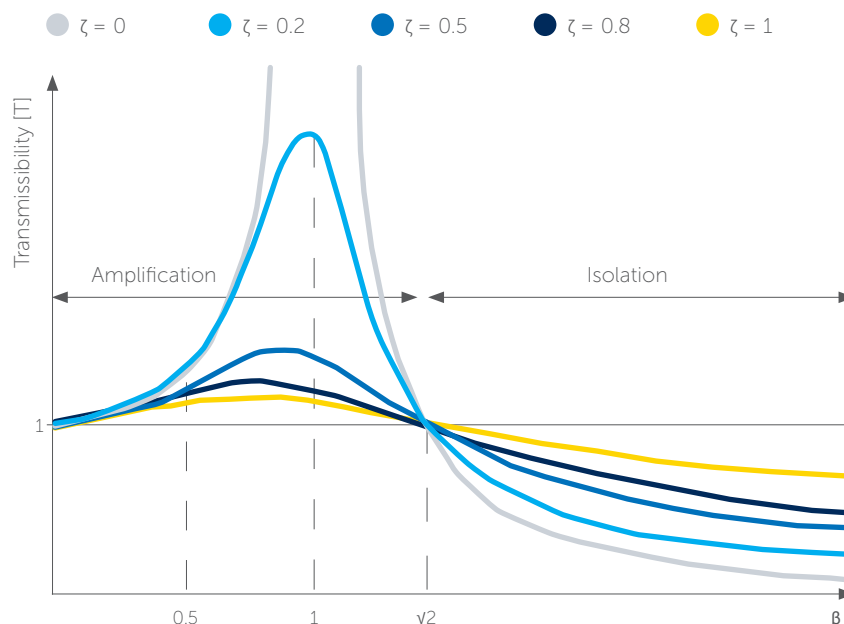

Figure 1 - Transmissibility of systems with and without damping.

As damping increases, the transmissibility curve becomes more flattened. This means that in the vicinity of resonance, transmissibility decreases, but it increases in the frequency range where isolation is needed, although it may be less efficient in this region.

When an isolator has significant damping, its natural frequency must be decreased to maintain the desired level of isolation within the relevant frequency range.

For instance, consider an isolator with a natural frequency of 8Hz, 3% damping, and a machine running at 1500 rpm, generating a dynamic disturbance at 25Hz. This setup would result in a 88.4% reduction in vibration (isolation (I)), equivalent to a 39dB reduction in vibration level. However, incorrect selection ($\beta < \sqrt{2}$) can lead to amplification, exacerbating the issue.

Moreover, it is advisable to implement a single, well-designed isolation system rather than multiple vibration isolators. Multiple isolators can introduce multiple mass-spring systems that might interfere with each other, potentially causing amplification issues instead of achieving the intended isolation.

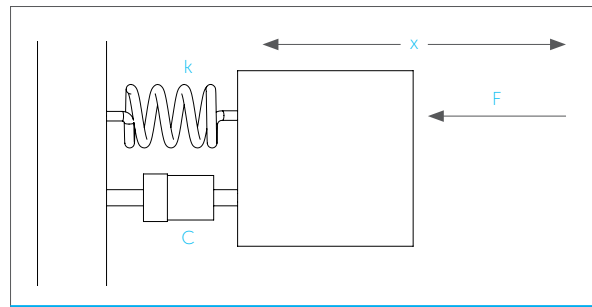

Figure 2 - Mass-spring-damper setup.

MAIN DESIGN CONSIDERATIONS

- Equipment type
- Is the equipment pre-existing or newly installed?
- Characteristics of the equipment:
 1. Are anti-vibration mounts already incorporated?
 2. Mode of operation: static, rotational, impact, or a combination thereof
 3. Excitation frequencies and magnitude of forces to be mitigated
 4. Distribution of static mass (center of gravity)
 5. Footprint of contact points (point, linear, or full surface)
 6. Physical dimensions
 7. Equipment stability requirements (incl. seismic or wind forces)
- Connections associated with the equipment, such as pipes or ductwork, both within the equipment and the building
- Required acoustic and mechanical performance levels
- Location of the equipment within the building (e.g. foundation slab, interim structural floor, relation to sensitive spaces, middle span or stiff spot of the structural slab, etc.)
- Physical and mechanical attributes of the supporting structure
- Operational temperature range
- Environmental conditions (acidic, salty, wet, windy, UV-exposed, ozone-prone)
- Available time frame for installation
- Any pre-existing constraints, e.g., space limitations, pertinent to implementing a new mitigation solution



Isolated Inertia Bases

Different Types

Inertia bases, used in conjunction with the right acoustic isolation system, are the most effective anti-vibration technique for machinery isolation.

Inertia bases can be either a simple steel frame fixed to the machine and decoupled by means of isolators, or they can consist of large concrete masses or floors (usually located under the concerning machine) which are supported by isolators. The increased mass of the concrete system reduces vibration amplitudes, lowers the center of gravity thereby reducing rocking, increasing thrust resistance, and operating stability. The use of an inertia base also contributes to better load distribution which, in turn, improves control over the correct working load of the selected isolator.

Inertia Bases or Floating Floor?

Inertia bases can be designed to suit a wide range of acoustic/mechanically requirements and to fit within a similarly wide range of locations, and can be either over an entire floor ([floating floor](#)) supporting multiple machines or be a smaller footprint for just one machine or small groups of machines ([inertia block](#)). Inertia blocks can also be incorporated into the floor thereby eliminating "a physical upstand".



Floating Floors

- High speed of construction
- Easy and straightforward installation
- Potentially flexible (future) equipment layout (TBC by design team)
- Services can be integrated into the floor void
- Even distribution of loads across the slab (no concentrated loads) base
- High airborne sound isolation
- Integrated lateral restraint can be included
- Stable base for mechanical equipment
- Easy to avoid hard connections, reducing vibration transmissions through structure and supporting equipment



Inertia Blocks

- Low total load
- Allows custom/optimal design per machine
- Integrated lateral restraint can be included
- Can be designed for isolators to be accessible, offering the possibility to optimize/modify those later
- Considerably lowers the center of gravity thereby reducing rocking, increasing thrust resistance, and operating stability
- Recommended in loosely designed spacious machine rooms with large unused floor surfaces



Isolated Inertia Bases Overview

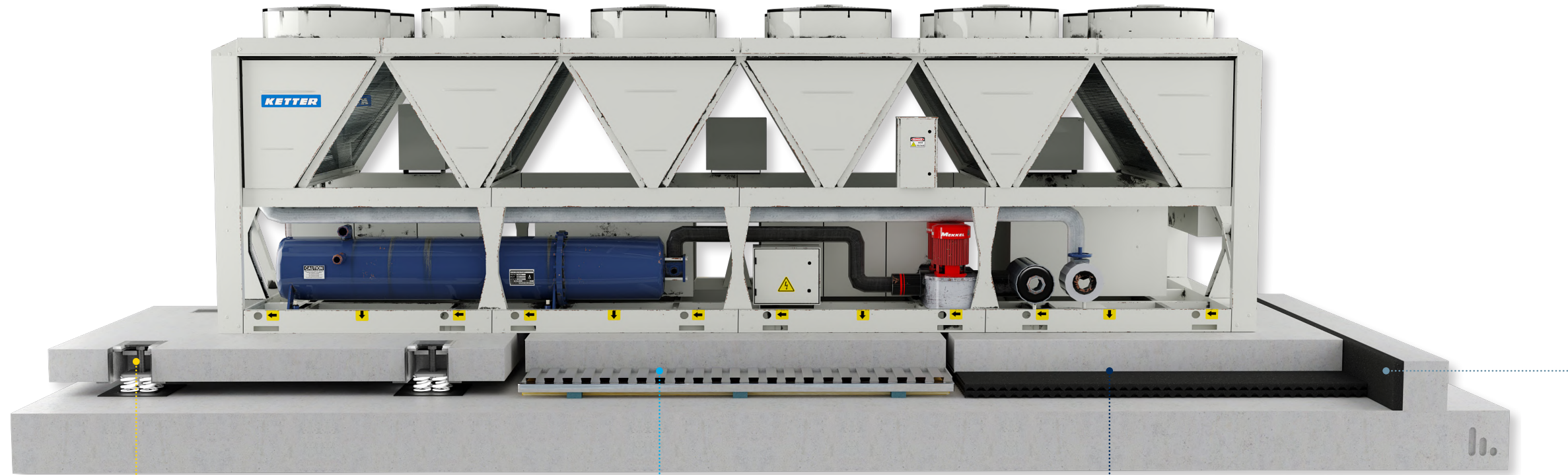

1 STRAVIFLOOR JACKUP-R

Replaceable/inspectable jack-up system, with low risk of acoustical bridging and few contact points. Future proofing solution.

Natural frequency:
Elastomeric pads: $\geq 6\text{Hz}$
Steel springs: $\geq 2.5\text{Hz}$

2 STRAVIFLOOR DECK

Low-profile discrete system with high bending stiffness and extremely high permissible loads. Fully non-organic solution.

Natural frequency:
Elastomeric pads: $\geq 6\text{Hz}$
Steel springs: $\geq 2.5\text{Hz}$

3 STRAVIFLOOR MAT

Low-profile roll-out isolation solution.

Natural frequency:
Elastomeric mats: $\geq 10\text{Hz}$

4 LATERAL RESTRAINT

Lateral restraints are available as continuous or discrete solutions.



Other [Stravifloor](#) systems, such as the discrete floating floor system - [Stravifloor Mount](#) and the isolated steel batten system - [Stravifloor Channel](#), may also be suitable for the acoustic decoupling of inertia bases. The correct selection should always be made according to the project-specific requirements. Inertia bases can even be supported by [Stravimech Bearing-Air](#), an air mount.

→ Visit our website for more info.
www.cdm-stravitec.com



Stravifloor Mount



Stravifloor Channel

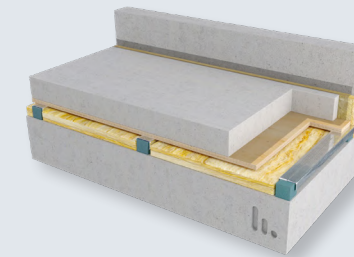

Stravimech Bearing-Air



Anti-vibration Mounts

Overview

Based on the specific needs of a project and the associated design considerations, one potential approach to isolating building services and mechanical equipment or safeguarding sensitive instrumentation could involve the installation of resilient bearings directly beneath the equipment.

This approach becomes a viable choice under the following circumstances:

1. the equipment has a stable operating regime;
2. dynamic operating forces are not significant;
3. load distribution over the supports is either uniformly distributed or well-documented, allowing for placement of isolators adapted to the load;
4. load variations are insignificant across the different operation phases;
5. in cases where practical constraints prevent the application of an inertia base.

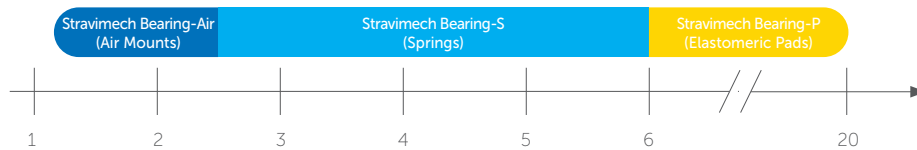

Figure 3 - Mount selection based on natural frequency (f_r).



Stravimech Bearing-P Elastomeric Support

A diverse array of elastomeric bearings is available, with a choice of material type (whether it's a single material or a combination of several) being contingent upon project specifications, including factors such as performance (level of isolation), load, contact surfaces, temperature range, UV resistance, ozone resistance, chemical resistance, and more.

Note: if there is a possibility of strong winds or other horizontal forces, necessitating the secure anchoring of the equipment, an isolated fixation solution can be designed utilizing elastomeric pads - see next section on fixation/anchoring systems.



Stravimech Bearing-S Spring Support

A comprehensive selection of spring mounts, including open, enclosed, and restrained variants. Stravimech Bearing-S is particularly well-suited for equipment operating at low speeds and is offered in various load capacities to accommodate both lightweight and heavy machinery.

Standard springs are epoxy coated, suitable for C2 environments.* Springs with special coating or special spring materials are available upon request for installation in outside conditions or other special environments.

Note: if there is a possibility of strong winds or other horizontal forces, necessitating the secure anchoring of the equipment, an isolated fixation solution can be designed utilizing springs - see next section on fixation/anchoring systems.

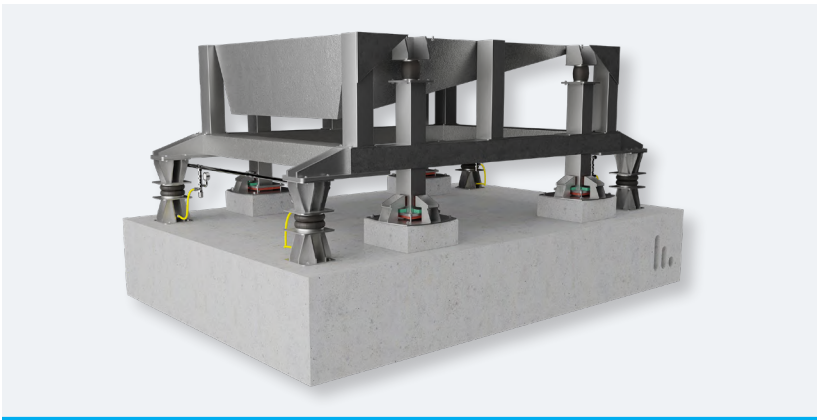

Stravimech Bearing-Air Air Support

Figure 4 - Graphic representation of machine isolation at 'Adega Cooperativa de Alijó' (PT)

This solution offers exceptionally high levels of isolation, achieving extremely low natural frequencies. It can be seamlessly incorporated as a support system for critical equipment within an existing structure, complemented by additional features like lateral buffers and fail-safe bearings (as illustrated on render).

Note: the equipment shown on these 3 renders is just for illustration purposes. These solutions can be used to support the most diverse types of building services and mechanical equipment.

* Corrosivity category of the environment: C2 Environments externally typically are mostly rural areas with atmospheres with a low level of pollution. Internally, C2 environments are unheated buildings where condensation may occur.

Fixation/Anchoring Systems

Overview

Frequently, the needs arise to decouple and elastically anchoring the equipment to its supporting structure. The use of [Stravimech Fix](#) helps reducing transmission of vibrations from the machine to its support while introducing a lateral/restraint.

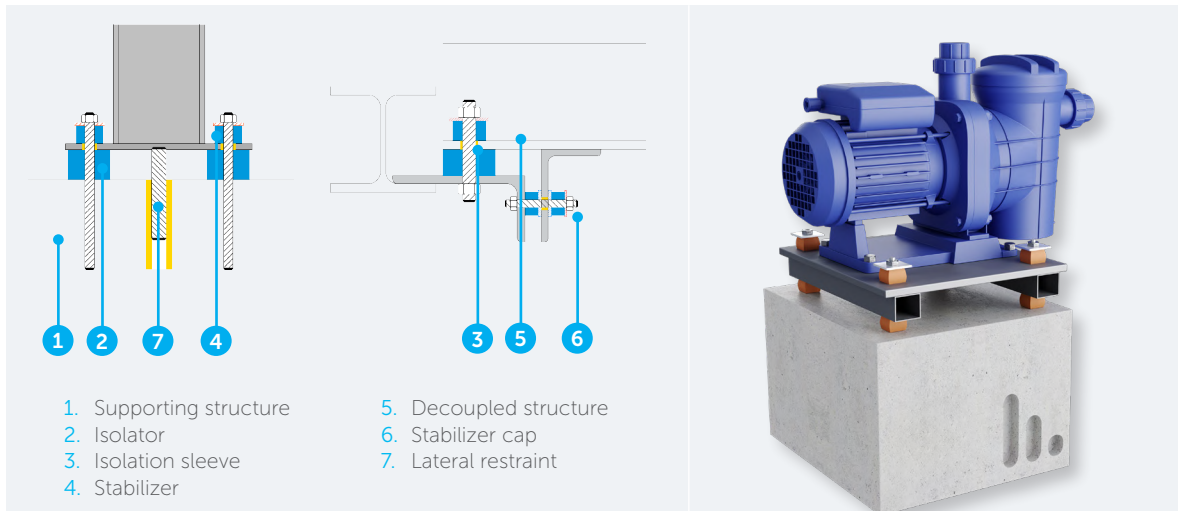

Figure 5 - 2D section of isolated fixation principle - concrete & steel structures.

Figure 6 - Visual representation depicting the elastic mounting of swimming pool pumps (actual project: Zwembad De Beeltjens Westerlo - BE).

As contemporary urban landscapes evolve with an ever increasing number of skyscrapers, there's a growing demand for faster and more efficient elevators to transport people over greater heights. In such scenarios, it becomes essential to implement isolation measures for the machine rooms, the machinery housed within them, and the elevator guiding rails. This is done to prevent disturbances to nearby occupants and to minimize the transmission of structural noise. Additionally, techniques like isolated fixation are employed to separate lift doors from the shaft walls, and electrical switchboxes are also isolated for optimal performance.

The Stravimech Fix concept offers tailored solutions designed specifically for this particular use case, known as [Stravimech ElevatorFix](#).



Figure 7 - Stravimech ElevatorFix.

stravimech

by CDM Stravitec



Suspension Systems Overview



The piping and ductwork systems connected to and from the disturbing machinery should receive equal attention to ensure proper isolation. This can be achieved by employing Stravilink resilient hangers to either decouple these systems or suspend the equipment itself. For instance, an increasing number of air handling units (AHUs) are now designed as suspended units, positioned between the suspended ceiling and the structural slab.



Figure 8 - Depiction of an elastic suspension system designed for sliding garage doors and their accompanying motor, featuring Stravilink PHR. This setup is further enhanced by employing Stravimech Fix for the elastic attachment of the rails.



Figure 9 - Visual representation demonstrating the suspension of pipes using Stravilink ICH-S hangers.

Note: the depicted pipework, devices, and suspension solutions in these renders are purely for illustrative purposes. Stravilink offers a range of solutions that can be applied to suspend various types of equipment, pipework, and peripheral devices, among others.



Visit our website for more Stravilink solutions.
www.cdm-stravitec.com



Q&E Management

CDM Stravitec nv operates ISO 9001:2015 and ISO 14001:2015 approved quality and environmental management systems.



References

At CDM Stravitec, we are proud of our track record in successfully addressing noise and vibration isolation challenges related to mechanical equipment and building services. With a legacy dating back to 1951, our portfolio boasts many accomplished projects. Our project diversity spans commercial and residential structures, manufacturing facilities, medical centers, educational institutions, hospitality establishments, fitness centers, and a variety of others.

Volkswagen Autoeuropa

Palmela (PT)
Stravifloor Prefab



Penn Presbyterian Medical Center

Philadelphia (US)
Stravifloor Jackup-R

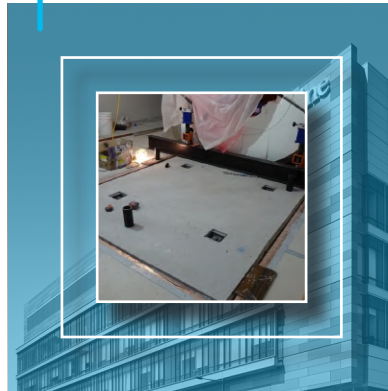

National Lottery

Brussels (BE)
Stravilink PHR

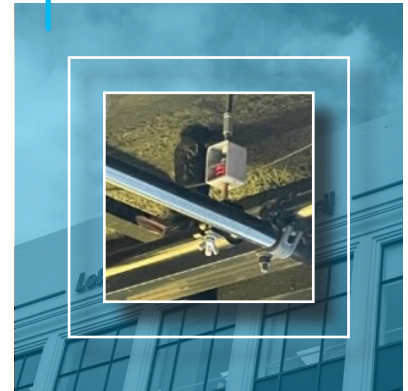

University of Pannonia

Veszprém (HU)
Stravimech Bearing-Air



Palácio Nacional da Ajuda

Lisbon (PT)
Stravifloor Deck



De Vier Gravinnen

Tiel (NL)
Stravimech ElevatorFix



Great job! Measurement results showed that transmissibility reductions from 9Hz and above are greater than 92%. Thus, the system works as designed and the randomly occurring base building peaks at 15Hz are well below the threshold provided by Siemens. So all is well.

Metropolitan Acoustics | Penn Presbyterian Medical Center

cdm stravitec

Making your world a quieter place

We have qualified engineers in noise and vibration based at different locations around the world – they are only a phone call away.

For general enquiries please contact our head office or visit our website.

Canada

100 Sunrise Avenue, Unit 202
Toronto, Ontario, M4A 1B3
T (905) 265-7401
info-ca@cdm-stravitec.com
www.cdm-stravitec.com

United States

342 N. Queen St., Warehouse D
Lancaster, PA 17603
T (888) 454-6236
info-us@cdm-stravitec.com
www.cdm-stravitec.com



Version 1 | 14/03/2024 - © 2024 CDM Stravitec n.v. All rights reserved.

DISCLAIMER

This information is accurate to the best of our knowledge at the time of issue. Information, data and recommendations provided are based on industry accepted testing and prior product usage. It is intended as descriptive of the general capabilities and performance of our products and does not endorse applicability for any particular project. We reserve the right to change products, performance, and data without notice. This document replaces all information supplied prior to the publication hereof. The renders and details present on this document are intended solely for illustration purposes only. The actual components of the final solution may undergo variations, intricately adjusted to the unique details of each project.