

Stravifloor Jackup-R Datasheet

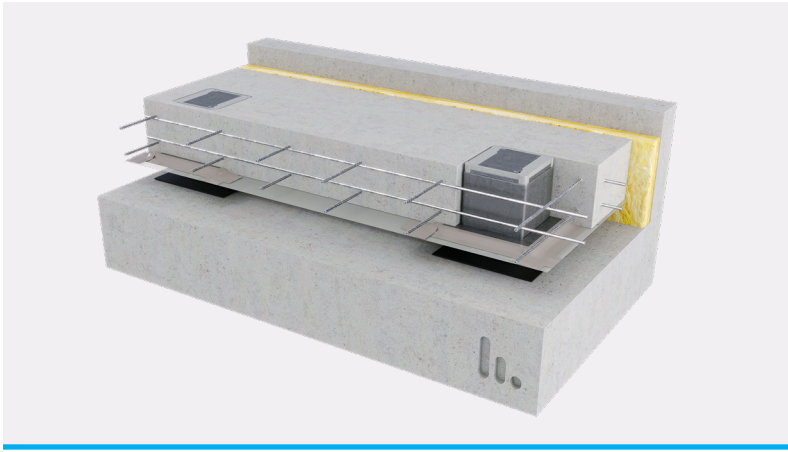

Stravifloor Jackup-R is an isolated floating floor system using [reinforced steel boxes](#) cast into concrete and jacked up after the concrete has cured, to provide the required void depth.

Once the concrete has cured, the isolated slab is raised off the structure to the required void depth. Stravifloor Jackup-R boxes [allow for easy adjustment of the final floor height as well as replacement or inspection of isolators](#), should the use of the room or load conditions change in the future.

Stravifloor Jackup-R boxes have an extremely high load capacity and, therefore, allow for larger spans and fewer support points than traditional jack-up systems, to provide a cost-effective solution. Stravifloor Jackup-R reduces the risk of acoustic bridging between the floating floor slab and the subfloor.



CHARACTERISTICS

- Can be provided with elastomer bearings giving a natural frequency as low as 6Hz, or spring mounts giving a natural frequency of 4.5Hz or 3Hz*
- Standard box heights are 100 mm, 150 mm and 200 mm (any height from 100 mm upwards can be manufactured to special order or project requirement)
- Stravifloor Jackup-R boxes have a maximum load per box of 38kN or 63kN (if reinforced) allowing large spans between boxes
- Steel components are centrifugal hot-dip galvanised
- The springs or elastomers within the Stravifloor Jackup-R are easily accessible by unscrewing the box lid which means they can be changed at any time should there be a change to the loadings or performance criteria
- Reduces the risk of having a bridge between the slab and the structure, isolation is guaranteed because the whole slab is lifted (there is no opportunity for any debris to be left in the cavity and any bridging is broken when the slab is lifted up)
- Can have a shallow or adjustable air gap
- Can take high loads before the slab is raised (e.g. used as a storage area during construction)
- Eliminates the cost and need for combustible, rot prone plywood forms

* Standard springs are epoxy coated, suitable for C2 environments. Springs with special coating or special spring materials are available upon request for installation in outside conditions or other special environments.



SYSTEM COMPONENTS

Stravifloor Jackup-R box (elastomers)

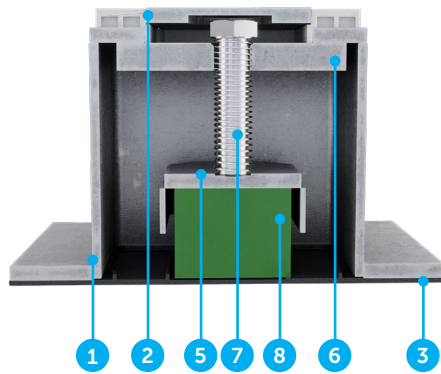

- 1. Reinforced steel box
- 2. Box lid
- 3. Bottom plate
- 4. Spring plate
- 5. Bearing cap
- 6. Adjustment plate

Stravifloor Jackup-R box (springs)

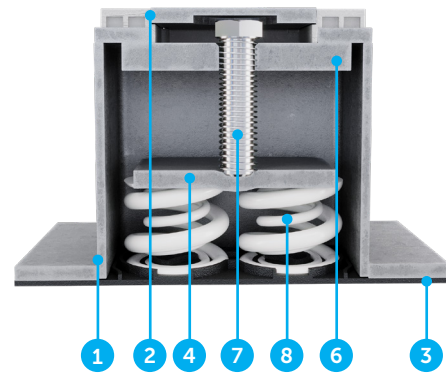

- 7. Bolt
- 8. Isolator (elastomer or spring)



PHYSICAL & MECHANICAL PROPERTIES

Standard Elastomeric Pads

Quantity (units)	Type	Dimension (mm)	ADL = DL+LL/3 (kN)	f_{res} @ ADL (Hz)	TL = DL+LL (kN)
1	Pad-H	64x64x50	4.1	6	4.9
1	Pad-H	64x105x50	6.7	6	8.1
1	Pad-X	64x64x50	8.2	7	12.3
1	Pad-X	64x105x50	13.4	7	20.2
1	Pad-U	55x55x50	19.7	10	24.2
1	Pad-U	64x64x50	26.6	10	32.8
1	Pad-U	64x105x50	43.7	10	53.8

Standard Spring Solutions

Spring 4kN/4,5Hz (h = 50 mm)	Spring 1.35kN/4,5Hz (h = 50 mm)	Spring 20kN/3Hz (h = 118 mm)	ADL = DL+LL/3 (kN)	TL = DL+LL (kN)
---------------------------------	------------------------------------	---------------------------------	-----------------------	--------------------

Quantity (units)	Quantity (units)	Quantity (units)		
4	4		21.4	25.9
4	2		18.7	22.8
4			16	19.6
2	4		13.4	16.1
2	2		10.7	13
2			8	9.8
		1	20	26

Maximum distance between boxes: Stravifloor Jackup-R100

Reinforcement	Live load (kN/m ²)	Spans assessed (m)									
---------------	-----------------------------------	--------------------	--	--	--	--	--	--	--	--	--

		1.8	1.9	2.0	2.1	2.2	2.3	2.4	2.5	2.6	2.7
Single	3	●	●	●	●	●					
Single	5	●	●	●							
Double	3	●	●	●	●	●	●	●	●	●	
Double	5	●	●	●	●	●	●				

Single: one A393* mesh with 40 mm bottom clear cover (and 40 mm top clear cover).
 Double: two A393* mesh with 30 mm bottom clear cover (and 30 mm top clear cover).

The hereby suggested distances between the Stravifloor Jackup-R boxes (and distances to the floor edges), as well as the possibly suggested steel reinforcement of the floating floor, should be considered as general guidelines for design & construction and are therefore solely given for information purposes. CDM Stravitec cannot be held responsible for any implementation in a specific project. For each project a specific calculation must be made by the stability engineers appointed by the client, in function of the particularities of the project, the required dead and live loads, etc.

Maximum distance between boxes: Stravifloor Jackup-R150 & Jackup-R200

System/Slab thickness (mm)	Reinfor.	Live load (kN/m ²)	Maximum span (m)															
			2.5	2.6	2.7	2.8	2.9	3.0	3.1	3.2	3.3	3.4	3.5	3.6	3.7	3.8		
Jackup-R150	A252 (2)	5	●															
Jackup-R150	A393 (1)	5	●	●	●													
Jackup-R150	A252 (2)	3	●	●	●	●												
Jackup-R200	A252 (2)	5	●	●	●	●												
Jackup-R200	A252 (2)	3	●	●	●	●												
Jackup-R150	A393 (1)	3	●	●	●	●	●	●										
Jackup-R200	A393 (1)	5	●	●	●	●	●	●	●	●	●							
Jackup-R200	A393 (1)	3	●	●	●	●	●	●	●	●	●	●	●	●	●	●	●	

Reinforcement option (1) uses a top and bottom A393* mesh with 40 mm top and bottom clear cover.
 Reinforcement option (2) uses a top and bottom A252** mesh with 40 mm top and bottom clear cover.

* Standard reinforcement grid with Ø10 mm rods with a spacing of 0.2 m
 ** Standard reinforcement grid with Ø8 mm rods with a spacing of 0.2 m

The hereby suggested distances between the Stravifloor Jackup-R boxes (and distances to the floor edges), as well as the possibly suggested steel reinforcement of the floating floor, should be considered as general guidelines for design & construction and are therefore solely given for information purposes. CDM Stravitec cannot be held responsible for any implementation in a specific project. For each project a specific calculation must be made by the stability engineers appointed by the client, in function of the particularities of the project, the required dead and live loads, etc.



Test Report AC-20-067-06 & AC-20-067-17 by Belgium Building Research Institute⁽¹⁾ - Test Setup

- 1. 150 mm (100 + 50 mm) reinforced concrete floating floor
- 2. Reinforced steel box with PAD-X50
- 3. PE-foil
- 4. 50 mm air void
- 5. 140 mm reinforced concrete slab

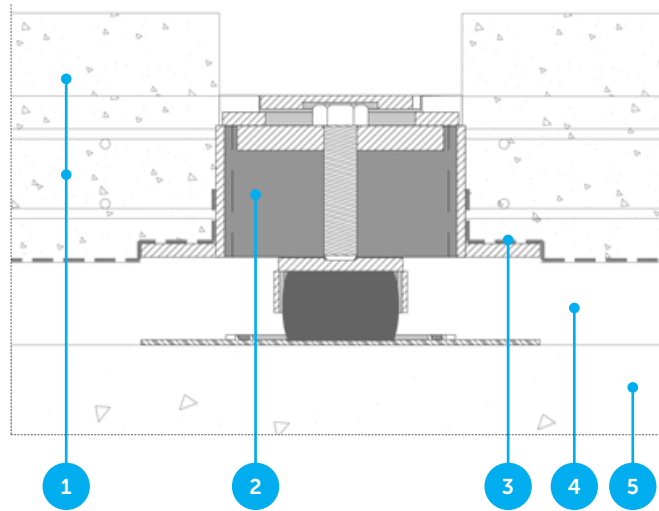

Acoustical Isolation

L_n [dB]

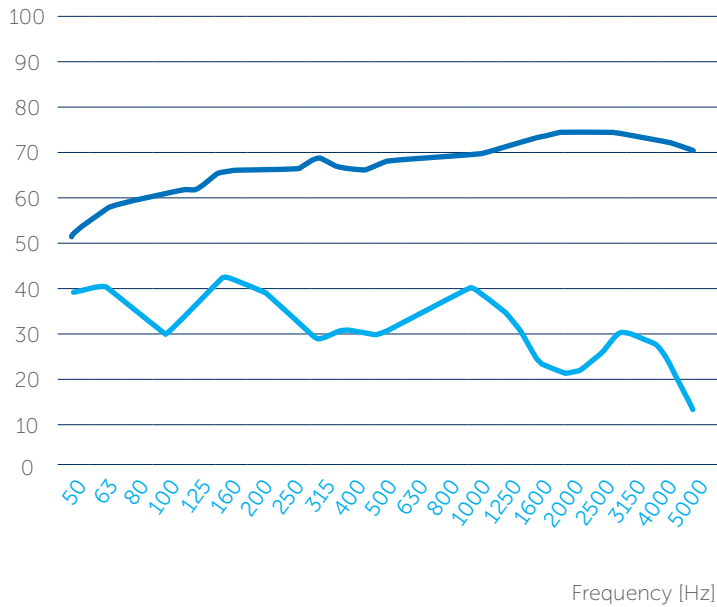

- L_n system with Pad-X50 and 150 mm concrete floating slab 50 mm air void
- $L_{n,0}$ (bare slab 140 mm)

⁽¹⁾Test report available upon request

Acoustical Isolation

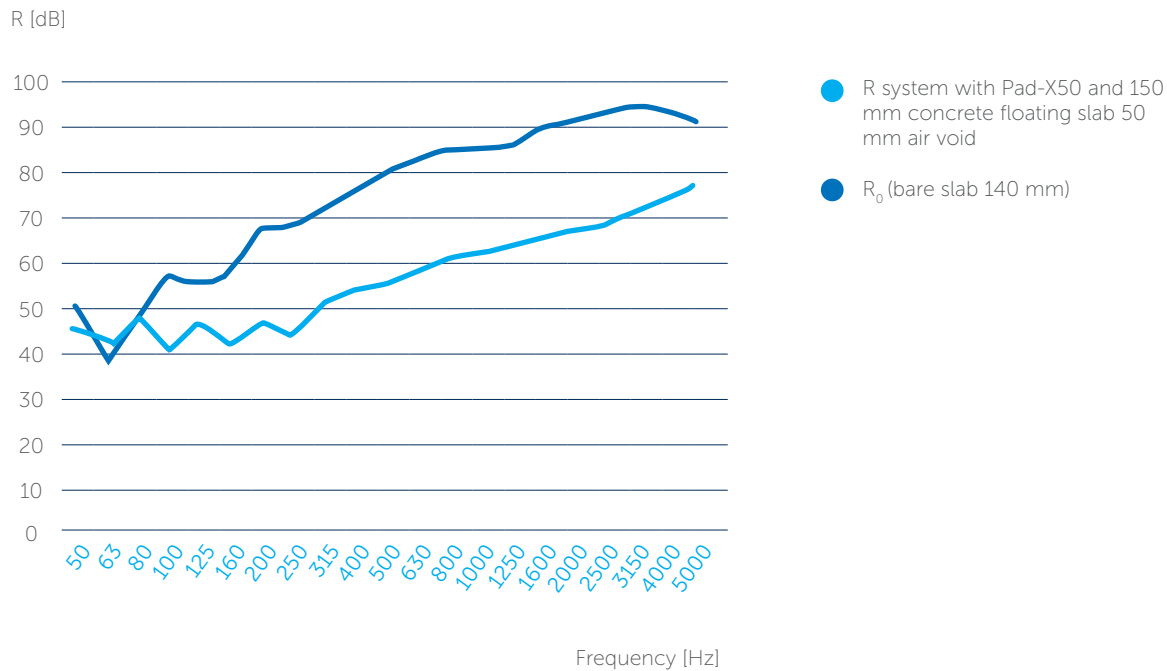

Setup	$L_{nw} (C_f)$	$\Delta L_w (C_f, \Delta)$	R (C _f)
System	38 (-5)	40 (-8)	79 (-3,-8)
Bare Slab	80 (-12)		59 (-2,-6)



Test Report AC-20-067-07 & AC-20-067-18 by Belgium Building Research Institute⁽¹⁾ - Test Setup

- 1. 150 mm (100 +50 mm) reinforced concrete floating floor
- 2. Reinforced steel box with 4.5Hz spring
- 3. PE-foil
- 4. 50 mm air void
- 5. 140 mm reinforced concrete slab

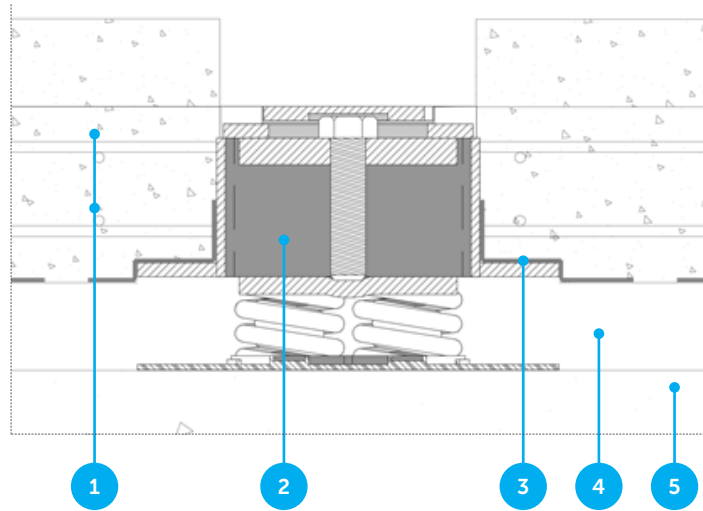

Acoustical Isolation

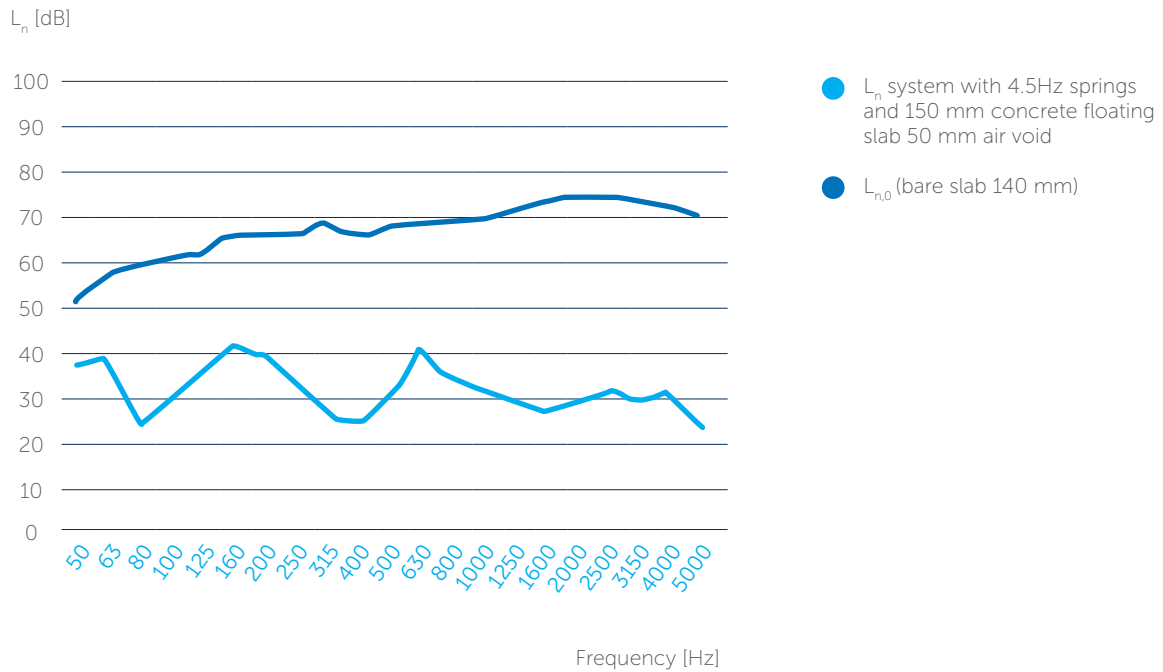

⁽¹⁾Test report available upon request

Acoustical Isolation

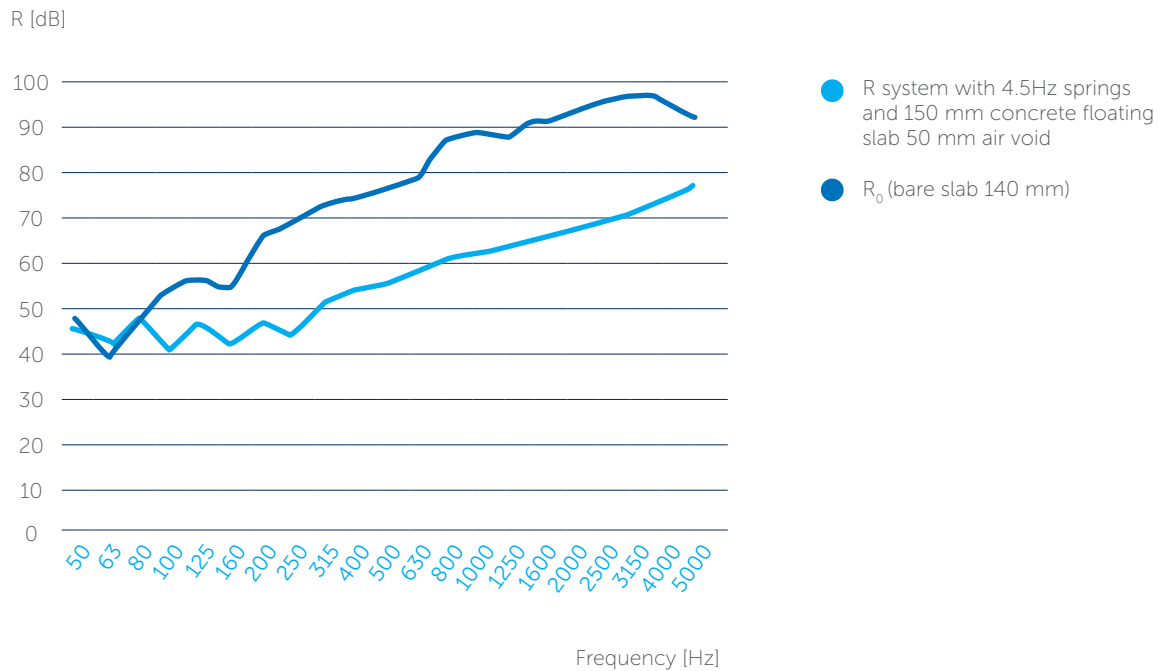

Setup	$L_{nw} (C_f)$	$\Delta L_w (C_f, \Delta)$	$R (C_f)$
System	37 (-5)	41 (-8)	77 (-3,-8)
Bare Slab	80 (-12)		59 (-2,-6)



TYPICAL ASSEMBLIES

Stravifloor Jackup-R with springs

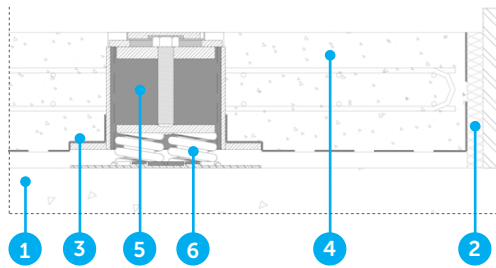

1. Reinforced concrete slab
2. Perimeter isolation
3. Protection foil (PE layer)
4. Reinforced concrete floating floor
5. Reinforced steel box
6. CDM Stravitec springs

Stravifloor Jackup-R with elastomeric pads

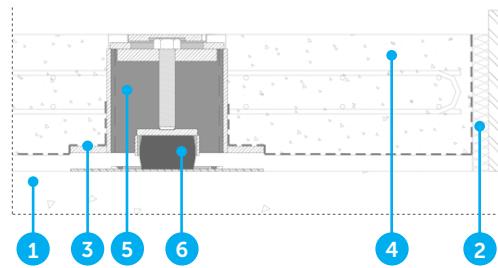

1. Reinforced concrete slab
2. Perimeter isolation
3. Protection foil (PE layer)
4. Reinforced concrete floating floor
5. Reinforced steel box
6. CDM Stravitec elastomeric pad

Note: an installation manual is available upon request.



Other Stravifloor Jackup-R assemblies available on our test data platform Stravi-dB.



SCAN
ME

DISCLAIMER

This information is accurate to the best of our knowledge at the time of issue. Information, data and recommendations provided are based on industry accepted testing and prior product usage. It is intended as descriptive of the general capabilities and performance of our products and does not endorse applicability for any particular project. We reserve the right to change products, performance, and data without notice. This document replaces all information supplied prior to the publication hereof.